

Stereo Cassette Deck

Operating Instructions

*TC-WR 570
TC-W 370
TC-WR 511
TC-W 411*

WARNING

To prevent fire or shock hazard, do not expose the unit to rain or moisture.

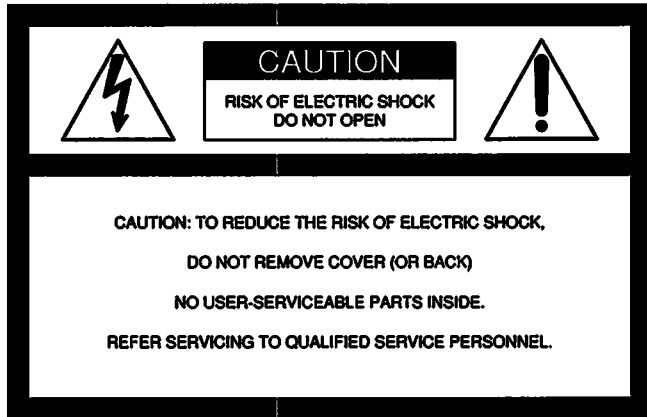

This symbol is intended to alert the user to the presence of uninsulated "dangerous voltage" within the product's enclosure that may be of sufficient magnitude to constitute a risk of electric shock to persons.



This symbol is intended to alert the user to the presence of important operating and maintenance (servicing) instructions in the literature accompanying the appliance.

* The graphical symbols are on the rear enclosure.

INFORMATION

This equipment generates and uses radio frequency energy and if not installed and used properly, that is, in strict accordance with the manufacturer's instructions, may cause interference to radio and television reception. It has been type tested and found to comply with the limits for a Class B computing device in accordance with the specifications in Subpart J of Part 15 of FCC Rules, which are designed to provide reasonable protection against such interference in a residential installation. However, there is no guarantee that interference will not occur in a particular installation. If this equipment does cause interference to radio or television reception, which can be determined by turning the equipment off and on, the user is encouraged to try to correct the interference by one or more of the following measures:

- Reorient the receiving antenna
- Relocate the equipment with respect to the receiver
- Move the equipment away from the receiver
- Plug the equipment into a different outlet so that equipment and receiver are on different branch circuits.

If necessary, the user should consult the dealer or an experienced radio/television technician for additional suggestions. The user may find the following booklet prepared by the Federal Communications Commission helpful:

"How to Identify and Resolve Radio-TV Interference Problems".

This booklet is available from the U.S. Government Printing Office, Washington, DC 20402, Stock No. 004-000-00345-4.

IMPORTANT (U.K. only)

The wires in this mains lead are coloured in accordance with the following code:

- Blue: Neutral
- Brown: Live

As the colours of the wires in the mains lead of this apparatus may not correspond with the coloured markings identifying the terminals in your plug proceed as follows: The wire which is coloured blue must be connected to the terminal which is marked with the letter N or coloured black. The wire which is coloured brown must be connected to the terminal which is marked with the letter L or coloured red. Do not connect either wire to the earth terminal in the plug which is marked by the letter E or by the safety earth symbol  or coloured green or green-and-yellow.

Owner's Record

The model and serial numbers are located at the rear. Record the serial number in the space provided below. Refer to these numbers whenever you call upon your Sony dealer regarding this product.

Model No. _____ Serial No. _____

Table of Contents

Getting Started

Features	3
Precautions	4
Installation	4
Connections	5
Identification of front panel parts	6

Playback

Playing back	7
Playing back both decks in succession —Relay Play	8
Playing back automatically after rewinding	
—Auto Play	9
Locating a selection	
—Automatic Music Sensor (AMS)	9

Recording

Recording (only on deck B)	10
Adjusting the recording level	11
What is the Dolby HX PRO system?	11
To protect a recording	12
Inserting a blank space during recording	
—Record Muting	12

Dubbing

Dubbing a tape	13
Dubbing only desired portions	14

Maintenance	15
Specifications	15
Troubleshooting guide	Back cover

Features

- **B and C type Dolby NR*** systems which reduce tape noise.
- **The AMS function** which provides easy access to a desired selection.
- **Synchronized dubbing** at normal or high (double) speed.
- **The Dolby HX PRO** system** which improves the linearity of the tape's high-range response during recording (TC-WR570 only).

* Dolby noise reduction manufactured under license from Dolby Laboratories Licensing Corporation.

"DOLBY" and the double-D symbol  are trademarks of Dolby Laboratories Licensing Corporation.

**Dolby noise reduction and HX Pro headroom extension manufactured under license from Dolby Laboratories Licensing Corporation. HX Pro originated by Bang & Olufsen.

"DOLBY", the double-D symbol  and "HX PRO" are trademarks of Dolby Laboratories Licensing Corporation.

Differences between the models

This instruction manual covers the TC-WR570, TC-W370, TC-WR511 and TC-W411. The TC-WR570 and the TC-WR511 have the following features which are not found in the TC-W370 or the TC-W411.

- Bidirectional tape movement
- Auto reverse

Precautions

On safety

- Operate the unit only on 120 V AC, 60Hz (U.S.A. model) or 240V AC, 50Hz (U.K. model).
- Before operating the unit, be sure that the operating voltage of your unit is identical with that of your local power supply.
- Should any solid object or liquid fall into the cabinet, unplug the unit and have it checked by qualified personnel before operating it any further.
- Unplug the unit from the wall outlet if it will not be used for a long time. To disconnect the cord, pull it out by grasping the plug. Never pull the cord itself.
- The unit is not disconnected from the ac power source (mains) as long as it is connected to the wall outlet, even if the unit itself has been turned off.

On operation

- When the unit is not used, turn the power off to conserve energy and to extend the useful life of your unit.
- Because of a safety mechanism, the function buttons will not operate if the cassette holder is not completely closed, if there is no cassette in the cassette holder, or if a cassette has been incorrectly inserted into the cassette holder.

On head cleaning

The head and tape path should be cleaned after every ten hours of operation. Dirty heads and a dirty tape path may cause:

- loss of high-frequency response
- loss of sound volume
- sound drop-out

If you have any questions or problems concerning your unit, please contact your nearest Sony dealer.

For detailed safety precautions, see the leaflet "IMPORTANT SAFEGUARDS". (U.S.A. only)

Installation

Notes on Installation

- Place the unit with the front panel facing you in a location with adequate air circulation to prevent overheating of the unit.
- Do not place the unit:
 - near heat sources such as radiators or air ducts.
 - in places subject to direct sunlight, excessive dust, mechanical vibration or shock.
 - in an inclined position.
 - on a rug or other soft surfaces that would block the ventilation holes on the bottom of the unit.

Do not throw away the carton and the packing material
They will come in handy when transporting the unit or shipping it for servicing.

Connections

Notes on Connections

- Turn off the power to all equipment to be connected before making any connection.
- Note that the red plug of the supplied connecting cord is for right-channel (R) connection and the white plug for left-channel (L) connection.
- The connecting cords should be fully inserted into the jacks. A loose connection may cause hum pickup.

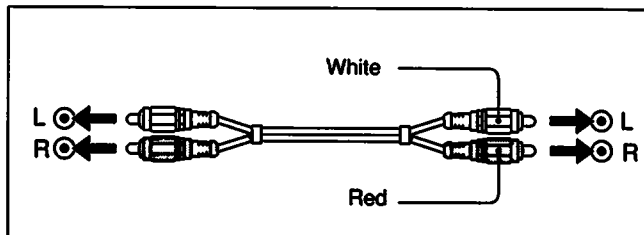

Basic Connection

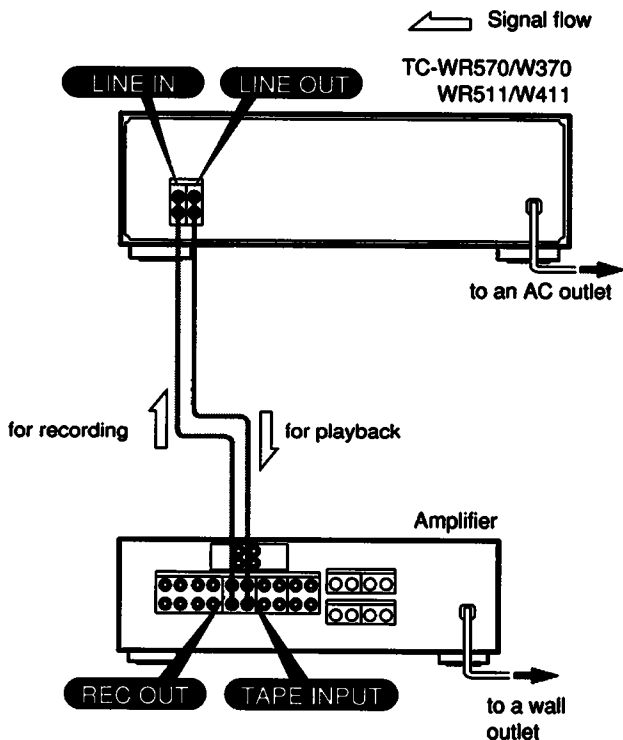

Identification of Front Panel Parts

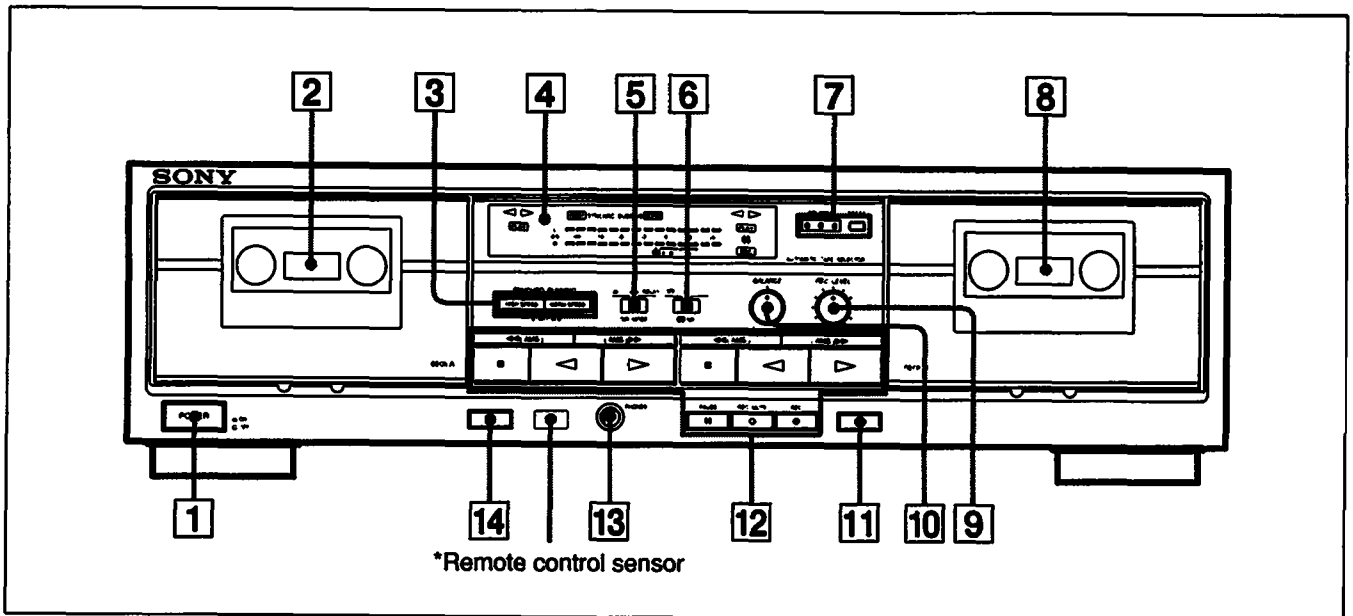

For details, refer to the page number indicated in ●

1 POWER switch

2 Deck A

3 SYNCHRO DUBBING buttons ●
HIGH SPEED button
NORM (normal) SPEED button

4 Display panel

5 DIR (direction) MODE switch
(TC-WR570/WR511 only) ● ● ● ● ●

6 NR (Dolby noise reduction) switch ● ●

7 Tape COUNTER and RESET button

8 Deck B

9 REC (recording) LEVEL control ●

10 BALANCE control ●

11 ⏏ (eject) button (deck B)

12 Tape operation buttons

- (stop) button
- ◀◀ (AMS**) (leftward fast winding) button
- ◀ (reverse play) button (TC-WR570/WR511 only)
- ▶▶ (AMS**) (rightward fast winding) button
- || PAUSE button (deck B only)
- REC MUTE (record muting) button (deck B only) ●
- REC (recording) button (deck B only)

13 PHONES (headphones) jack (stereo phone jack)

14 ⏏ (eject) button (deck A)

***Remote control sensor**

- You can remotely control this cassette deck with:
- A remote commander that came with a Sony amplifier or receiver if it has the ■ mark and cassette deck control capability.
 - Any optional Sony remote commander with the ■ mark and cassette deck control capability.

**AMS is an abbreviation for Automatic Music Sensor.

Playing Back

Follow the procedure below to play back a cassette on deck A or B.

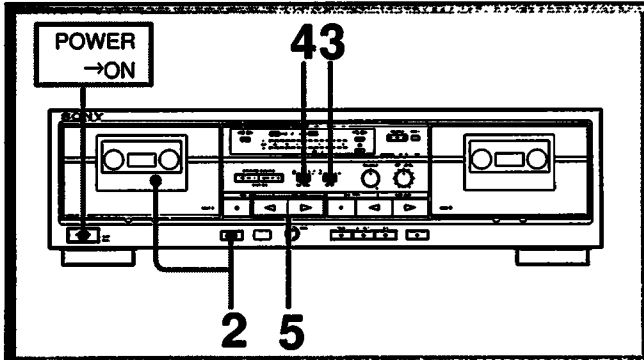

1 Turn on the amplifier and select the tape function.

2 Insert a cassette.

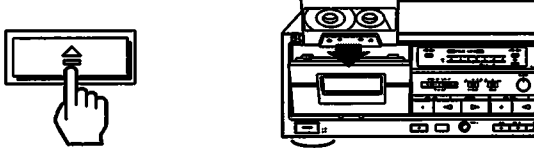

3 Set **NR** to the same position that was used when the cassette was recorded.



4 Select the direction mode (TC-WR570/WR511 only).

To play back to the end of one side only	<p>RELAY DIR MODE →</p>
To play back both sides continuously*	<p>RELAY DIR MODE ←</p>

* After playing back five times, the deck automatically stops.

5 Start playback.

From the front side	
From the reverse side (TC-WR570/WR511 only)	

Tape direction



To stop playback, press the **■** button.

To stop playback momentarily, press the **||** button (only on deck B).

To restart play, press the **||**, **◀** or **▶** button.

To fastwind a tape rightward, press the **▶▶** button in stop mode.

To fastwind a tape leftward, press the **◀◀** button in stop mode.

Is it necessary to set the tape type being used?

No. The deck has an automatic tape type detection system.

When decks A and B are in playback mode

Only playback from deck A will be audible.

What is the Dolby NR system?

The Dolby NR (noise reduction) system reduces tape hiss noise in low-level, high-frequency signals by boosting the signals during recording and lowering them during playback.

Note

The Dolby HX PRO system is effective only during recording, not during playback (TC-WR570 only).

Playing Back Both Decks in Succession — Relay Play

The Relay Play function plays back cassettes in deck A and deck B continuously and in consecutive order.

To stop relay play

Press the ■ button of the deck playing.

Playback sequence of relay play

Relay play always follows the sequence below regardless of where playback starts.

After playing back five times, Relay Play automatically stops.

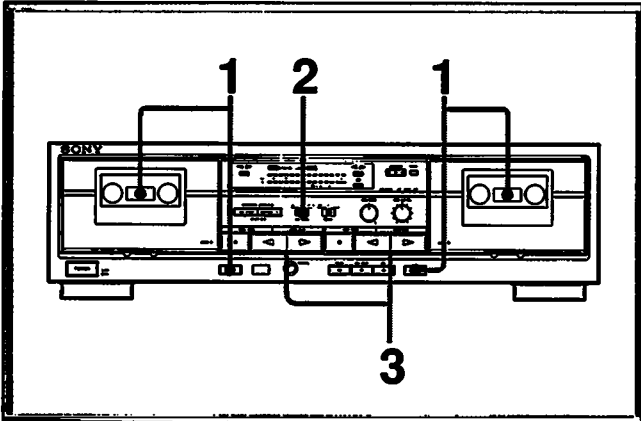

1 Insert cassettes into both decks.

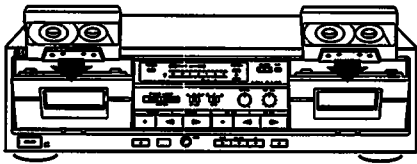

2 Set the direction mode to RELAY (TC-WR570/WR511 only).



3 Start playback of the cassette to be listened to first.

From the front side	
From the reverse side (TC-WR570/WR511 only)	

TC-WR570/WR511

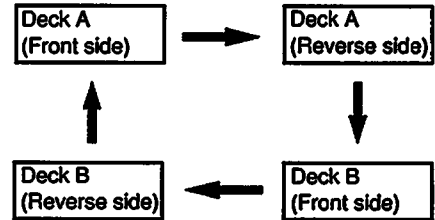

TC-W370/W411

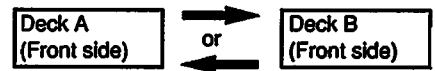

Playing back more than two cassettes in succession
Replacing cassettes that have finished playing with new ones allows you to play back two or more cassettes alternately on each deck.

Playing Back Automatically after Rewinding —Auto Play

The Auto Play function automatically starts playing back a cassette after fast winding it to the beginning.

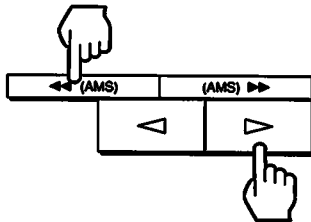
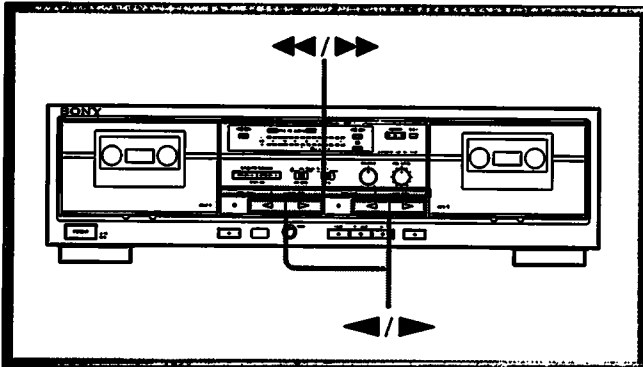



From the beginning of...	While pressing...
front side	▶▶, press ◀◀.
reverse side (TC-WR570/WR511 only)	◀◀, press ▶▶.

Locating a Selection —Automatic Music Sensor (AMS)

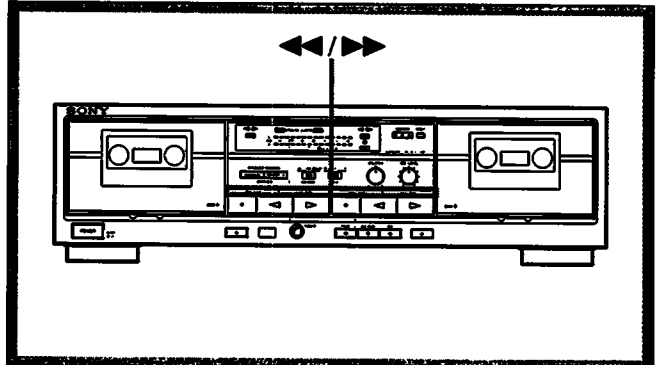
The AMS function detects the blank space between selections, allowing you to quickly locate the beginning of desired selections.



During playback, check the direction indicator and press ▶▶ or ◀◀ referring to the following table.

Direction Indicator	Desired selection	
	Next selection	Selection being played
	▶▶	◀◀
 (TC-WR570/WR511 only)	◀◀	▶▶

The PLAY indicator flashes while the AMS searches for the beginning of the selection. After locating the beginning of the selection, playback will start automatically.

The AMS may skip a selection in the following cases:

- If the ▶▶ (or ◀◀) button is pressed immediately before the following selection.
- If there is noise in the space between selections.
- If the space is less than four seconds long.

The AMS will treat the following as blanks:

- a long pause in the music
- a passage of low frequencies or very low volume
- a gradual increase or decrease in volume

The AMS does not function on both decks simultaneously

- The AMS is activated for the deck whose ▶▶ or ◀◀ button is pressed first.
- If the AMS is activated for deck B during playback on deck A, deck B fast winds to the beginning of the selection and stops.
- If the AMS is activated for deck A during playback on deck B, deck A fast winds to the beginning of the selection and begins playback. The sound from deck B will be cut off when playback begins on deck A.

Recording (Only on Deck B)

Follow the procedure below to record a source on a cassette (deck B only).

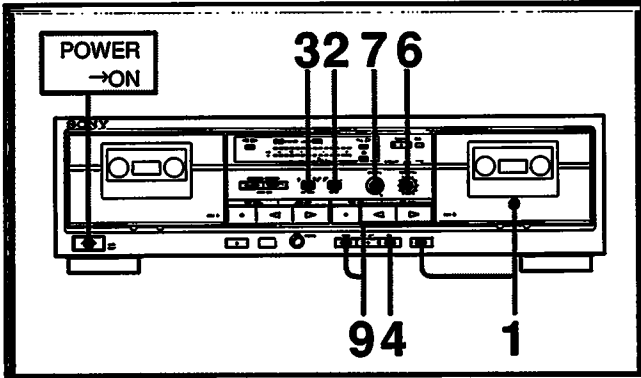

1 Insert a cassette.

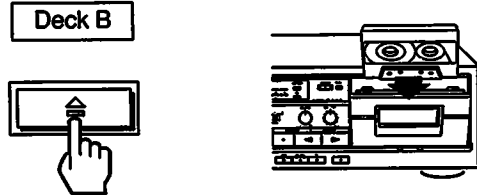

2 Select the Dolby NR setting.



3 Select the side(s) to be recorded (TC-WR570/WR511 only).

To record on one side	
To record on both sides	

4 Place the unit into recording standby mode.



5 Play the program source to be recorded.

6 Adjust the recording level.



See Adjusting the Recording Level on page 11.

7 Adjust the balance.



8 Restart the program source, if required.

9 Start recording.

• TC-WR570/WR511

To record on the front side of the cassette

When ▷ is on	Press ▶ once or .
When ◁ is on	Press ▶ twice.

To record on the reverse side of the cassette

When ◁ is on	Press ◀ once or .
When ▷ is on	Press ◀ twice.

• TC-W370/W411

Press ▶ or ||.

To stop recording
Press the ■ button.

If the tab has been removed from either side A or B Recording is impossible on this side(s).
To recover a cassette for recording, cover the respective slot with tape. See "To Protect a Recording" on page 12.

Note on step 3

Even at the ⇄ position, recording automatically stops when the tape reaches the end of reverse side (TC-WR570/WR511 only).

Note on step 9

Pressing the ◀ or ▶ button twice will cause the unit first to change tape direction and then start recording in that direction. (TC-WR570/WR511 only)

Adjusting the Recording Level

The optimum recording level, which differs according to the tape type, is indicated on the PEAK LEVEL METER for each tape type.

Adjust the REC LEVEL control as high as possible without exceeding the recommended range for the tape type being used.

Recommended maximum PEAK LEVEL METER reading

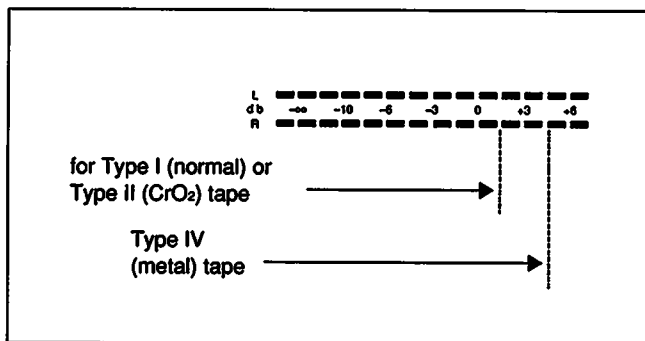

Tips on recording level adjustment

- If the recording level setting is too high, the recording will be distorted; if it is too low, the tape will produce a hissing sound. Therefore, the recording level should be set as high as possible without causing distortion.
- If the program source to be recorded has many high frequency signals, set the level to a relatively low position.

What is the Dolby HX PRO system?

The Dolby HX PRO system provides linearity in high-range frequency response during recording. Tapes recorded with this system retain the same high quality even when played back on other tape decks.

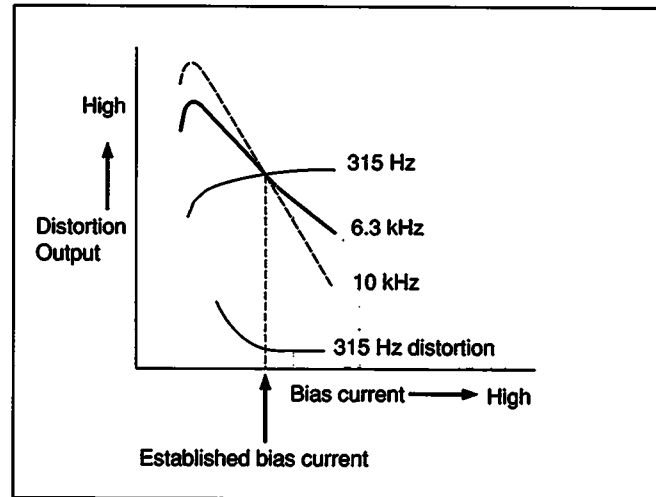

As shown above, characteristics such as output level and distortion differ widely according to the bias (high-frequency) current. In conventional systems, the bias current is susceptible to variations in certain recording signals (see diagram below) which may cause fluctuations in frequency response, distortion, or other unwanted characteristics.

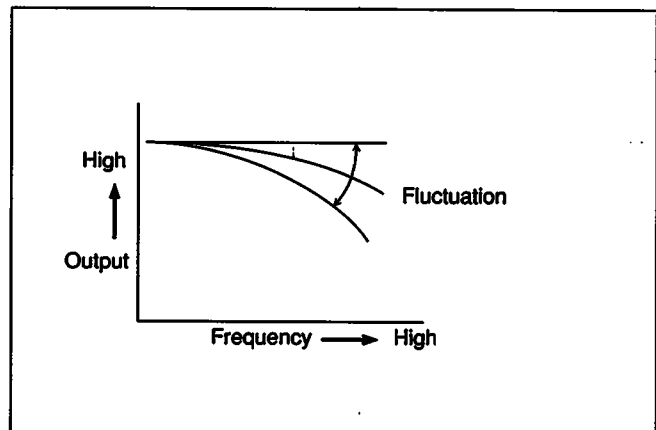

With the Dolby HX PRO system, the effective bias amount added to the bias current is controlled in millisecond units to greatly reduce distortion, improving linearity in high-range response and ensuring high-intensity recording with minimal distortion and noise.

Recording (Only on Deck B)

To Protect a Recording

To protect a recording on side A or B
Break out the respective tab.

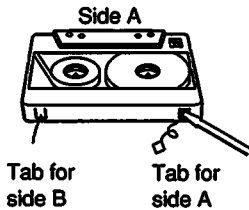

To recover a cassette for recording
Cover the respective slot with tape.

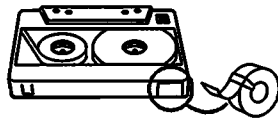

When using Type II (CrO₂) or Type IV (metal) cassettes
Be careful not to cover the detector slots which are necessary for automatic tape type detection.

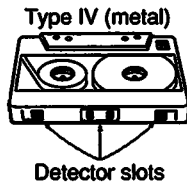
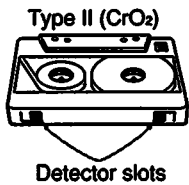

Cassette Care

- Avoid touching the tape surface of a cassette to prevent contamination of the heads by dirt, dust, or oil on the skin.
- Keep cassettes away from equipment with magnets, such as speakers and amplifiers, as erasure or distortion of the recorded tape could occur.
- Do not expose cassettes to direct sunlight, extremely cold temperatures, or moisture.

Note on cassettes longer than 90 minutes

The use of cassettes longer than 90 minutes is not recommended except for long continuous playback.

Inserting a Blank Space during Recording

—Record Muting

The Record Muting function allows you to insert a four-second blank to enable proper AMS operation (see page 9), and to replace unwanted input with a blank of any desired length.

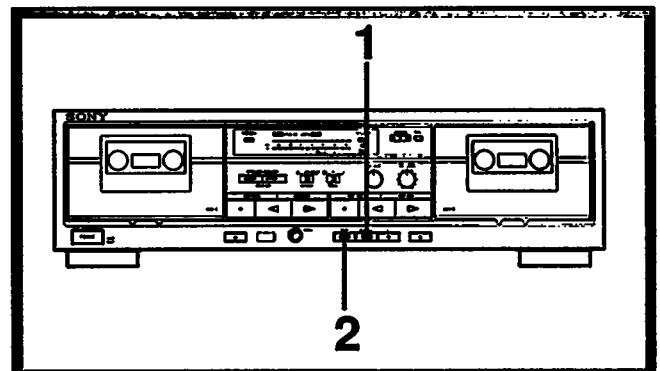

1 While recording, press **O** and release it immediately.



The **REC** indicator starts to blink. During this time, no incoming signals are recorded on the tape. After four seconds, the **|||** indicator lights up and the unit enters recording pause mode.

2 Resume recording.

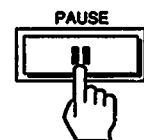

To create a blank longer than four seconds,
Press the **O** button for the desired length of time. After four seconds, the **REC** indicator blinks with greater rapidity. When you release the **O** button, the **|||** indicator lights up and the deck goes into recording pause mode. Press the **|||** button to resume recording.

Dubbing a Tape

High-speed dubbing allows you to dub a tape in deck A to a tape in deck B without making adjustments. High speed dubbing is convenient for dubbing entire tapes while normal-speed dubbing is handy for tape editing.

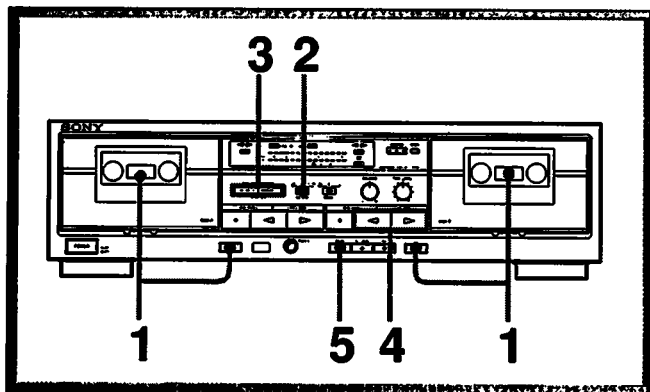

1 Insert cassettes.

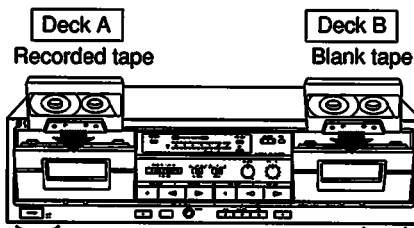

2 Select the direction mode (TC-WR570/WR511 only).

One side	
Both sides	<p>Dubbing of the reverse side starts independently of deck A.</p>
	<p>Dubbing of the reverse side starts simultaneously with deck A.</p>

3 Select the dubbing speed.

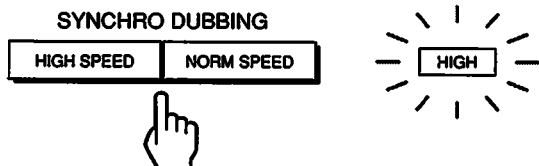

4 Select the side on which to start dubbing.

From the front side	
From the reverse side (TC-WR570/WR511 only)	

5 Start dubbing.

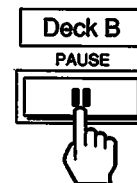

To stop dubbing

During normal-speed dubbing, press the ■ button on deck B.

During high-speed dubbing, press the ■ button on either deck A or B.

During high-speed dubbing
Only the ■ button is operative.

If the NORMAL or HIGH SPEED indicator blinks three times
Either one or both tabs of the cassette inserted into deck B have been removed, making dubbing impossible for that side. Cover the slot(s) with tape (see page 12).

Is it necessary to adjust the recording level and select the Dolby NR system?

It is unnecessary since the tape in deck B is automatically recorded with the same recording level and Dolby noise reduction system as the original in deck A.

The Dolby system must, however, be set to match the tape in deck A when the sound is monitored during normal-speed dubbing.

Notes on tape dubbing

- Do not change the dubbing speed setting during tape dubbing.
- If the sound is affected by the proximity of a television set during high-speed dubbing, turn the television set off or move it away from the deck.

Dubbing Only Desired Portions

Follow the procedure below to dub only desired portions of selections. Note that this is only possible in the normal-speed dubbing mode.

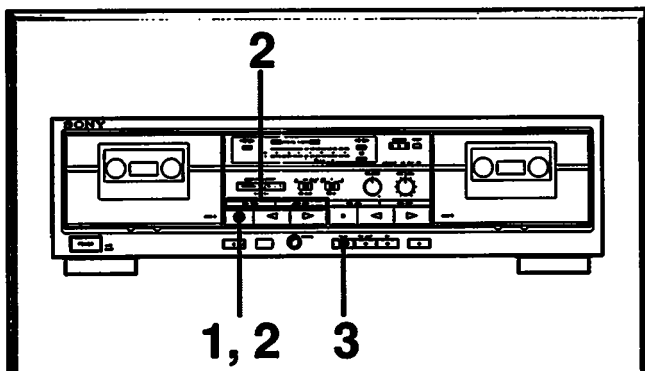

1 At the start of a selection to be skipped:

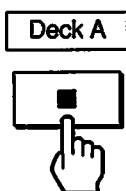

Deck A enters the stop mode and deck B enters the recording pause mode.

2 Locate the desired portion.

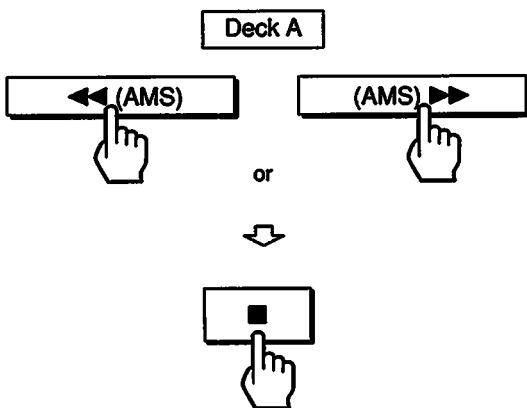

3 Resume dubbing.

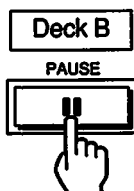

Maintenance

Cleaning the Heads and Tape Path

Clean all surfaces over which the tape travels after every ten hours of operation to guard against:

- low-quality sound
- a decrease in sound level
- excessive wow, flutter or drop-out
- incomplete erasure
- impairment of recording function

To obtain high-quality recorded sound, cleaning before every recording is recommended.

- 1 Press the  button to open the cassette holder. Grasp the front holder on both sides and gently lift to remove it.
- 2 With the unit turned off, wipe the heads, the pinch rollers and the capstans with a cotton swab slightly moistened with alcohol or a commercially available cleaning fluid for tape decks.

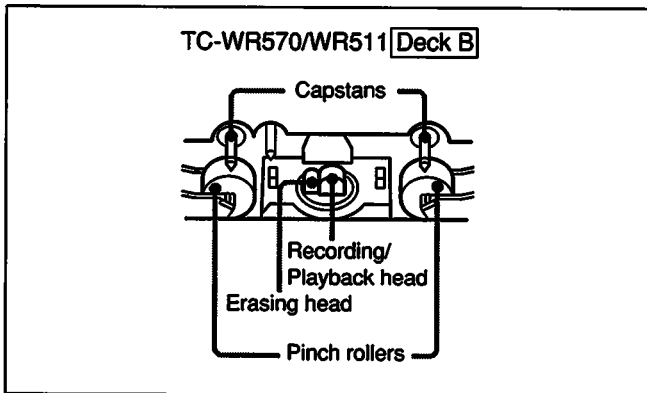

- 3 Replace the cassette holder.

Do not insert a cassette until the cleaned areas are completely dry.

Demagnetizing the Heads

After 20 to 30 hours of use, or when you notice hiss and/or loss of high frequencies, the residual magnetism built up on the heads should be removed.

- 1 Turn off the power.
- 2 Demagnetize the heads with any commercially available demagnetizer.

Refer to the instruction manual of the demagnetizer for detailed instructions.

Cleaning the Cabinet

Clean the cabinet, panel and controls with a soft cloth slightly moistened with a mild detergent solution. Do not use any type of abrasive pad, scouring powder or solvents such as alcohol or benzene.

Specifications

Recording system 4-track 2-channel stereo
 Fast winding time Approx. 90 sec. (with Sony C-60 cassette)
 Bias AC bias
 Signal-to-noise ratio (at peak level)

Cassette	Dolby NR switch		
	OFF	B-Type ON	C-Type ON
Type IV (Sony METAL-SLT/S)	58 dB	66 dB	73 dB
Type II (Sony UX-S)	57 dB	65 dB	72 dB
Type I (Sony HF-S)	55 dB	63 dB	70 dB

Total harmonic distortion 1.0% (with Sony METAL-SLT/S cassettes)
 Frequency response (DOLBY NR OFF)

Type IV cassette (Sony METAL-SLT/S)	30 - 15,000 Hz (± 3 dB, IEC) 30 - 13,000 Hz [± 3 dB 0VU (-4 dB) recording]
Type II cassette (Sony UX-S)	30 - 15,000 Hz (± 3 dB, IEC)
Type I cassette (Sony HF-S)	30 - 14,000 Hz (± 3 dB, IEC)

Wow and flutter $\pm 0.14\%$ W. Peak (IEC)
 0.08% WRMS (NAB)
 $\pm 0.19\%$ W. Peak (DIN)

Inputs

Line inputs (phono jacks)	Sensitivity	77.5 mV
	Input impedance	47 k ohms

Outputs

Line outputs (phono jacks)	Rated output level	0.32 V at a load impedance of 47 k ohms
	Load impedance	Over 10 k ohms
Headphones (stereo phone jack)	Output level	0.3 mW at a load impedance of 32 ohms

General

Power requirements

Model for U.S.A.:

120 V AC, 60 Hz

Model for the United Kingdom:

240 V AC (or 220 V AC adjustable by Sony personnel), 50/60 Hz

Power consumption

23 W

Dimensions

Approx. 430 x 125 x 285 mm (w/h/d)
 (17 x 5 x 11 1/4 inches)

including projecting parts and controls

Approx. 4.5 kg (9 lbs 15 oz)

Weight

Supplied accessory

Audio connecting cords (2)

Optional accessories

Sony size-AA (R6) batteries (2)

Design and specifications subject to change without notice.

Note

This appliance conforms with EEC Directive 87/308/EEC regarding interference suppression.

Troubleshooting Guide

The following trouble checks will help you correct the most common problems encountered with your tape deck.

Should any problems persist after you have made these checks, consult your nearest Sony dealer.

Before proceeding with these trouble checks, verify that:

- The power cord is firmly connected.
- Amplifier connections are firmly made.
- Heads, capstans and pinch rollers are clean.
- The amplifier controls and switches are set correctly.

Function buttons and tape transport problems

Symptom	Cause	Remedy
The function buttons do not activate.	The cassette holder is not fully closed.	Close the holder completely.
	The cassette is not properly inserted.	Insert cassette correctly.
	Button was pressed immediately after power was turned on.	Wait until the ■■ indicator stops blinking.
The ● button does not activate.	There is no cassette in the holder.	Insert a cassette.
	A tab has been removed from the cassette.	Cover the slot with tape (page 12).
Automatic shut-off mechanism activates before the tape comes to its end.	The tape is slack.	Take up the tape slack.
	The cassette shell is deformed.	Use another cassette.
Excessively loud tape transport noise during fast winding.	This noise is caused by the cassette and does not signify a mechanical problem.	—
The ▲ eject button does not function.	This occurs when there is a power failure or when the power cord is disconnected during playback or recording.	Reconnect the power.

Recording and playback problems

Symptom	Cause	Remedy
Recording or playback cannot be made or there is a decrease in sound level.	The recording/playback and erasing heads are either dirty or magnetized.	Clean or demagnetize the heads.
	Improper connection.	Make connections properly (page 5).
	Improper setting of the amplifier controls.	Set the amplifier controls to the appropriate positions.
Excessive wow, flutter or dropout.	The head, capstan or pinch roller is dirty.	Clean in accordance with instructions (page 15).
Incomplete erasure.	The erasing head is dirty.	Clean the erasing head.
Increased noise or poor reproduction in high frequencies	The head is magnetized.	Demagnetize the head.
Unbalanced tone in high frequencies.	Improper setting of the □□ NR switch.	During playing back, set the switch to the same position used in recording.
	The unit is placed near a television set.	Move the deck away from the television set.
The desired selection cannot be located even if you activate the AMS.	There is noise in the space between selections.	Rerecord the tape if you can, and insert a blank space of four seconds using the ○ button.
	The space is less than four seconds long.	
	The ►► (or ◀◀) button was pressed immediately before the beginning of the following selection.	—
Playback begins in the middle of a selection when the AMS function is activated.	The selection contains one of the following: — a long pause in the music — a passage of low frequencies or very low volume — a gradual increase or decrease in volume	While the tape is playing, press the ◀◀ or ►► button again.

Noise

Symptom	Cause	Remedy
Hum noise.	The unit is stacked on or under the amplifier.	Separate the unit.
Noise is recorded.	The recording was made near equipment such as a television set or a color monitor, and interference has affected the recording on the tape and the Dolby NR system.	Move the unit away from the television set or color monitor.